

251



MODEL NO	SİYAH (BLACK)	F1 (N)	F2 (N)	F3 (N)	F4 (N)	Fi		AÇI (ANGLE) (±5°)	AĞIRLIK (WEIGHT) (gr ±%2)
						(X1) VERİM (YIELD) (F1:Fi)	(X2) VERİM (YIELD) (F2:Fi)		
251-2	B251-....	470	380	700	560	3:1	2:1	90°	65
251-3	B251-....	1400	1030	1625	1200	3:1	2:1	90°	270
251-4	B251-....	2000	1370	3370	2445	4:1	2.5:1	90°	710

F1 - F2 : BASKI KUVVETİ (EXERTING FORCE) , F3 - F4 : TUTMA KAPASİTESİ (HOLDING CAPACITY) , Fi : UYGULAMA KUVVETİ (APPLIED FORCE)



251-L



Kilitli / Locked

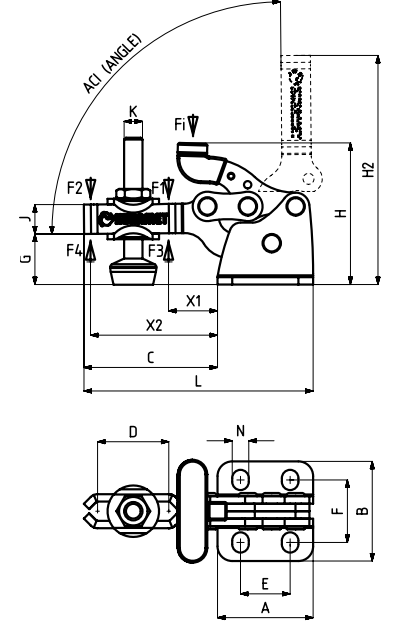

Ayak Tipi: Yatay Tabanlı
Body Mounting Base: Horizontal



211

Sayfa/Page: 17



111

Sayfa/Page: 6



251-L

Sayfa/Page: 38

MODEL NO	A	B	C	D	E	F	G	H	H2	J	K	L	N	X1	X2
251-2	26	27	36	17	13,5	17	14	38	62	8	M5	62	4.5x5.5	19	27
251-3	44	47	56	27	23	30	24	63	100	13	M8	100	7.5x8.5	27	43
251-4	64	63	79	37	35	39,5	36	93	143	19	M10	143	9x10.5	39	63

252



MODEL NO	SİYAH (BLACK)	F1 (N)	F2 (N)	F3 (N)	F4 (N)	Fi		AÇI (ANGLE) (±5°)	AĞIRLIK (WEIGHT) (gr ±%2)
						(X1) VERİM (YIELD) (F1:Fi)	(X2) VERİM (YIELD) (F2:Fi)		
252-2	B252-....	470	380	700	560	3:1	2:1	90°	65
252-3	B252-....	1400	1030	1625	1200	3:1	2:1	90°	270
252-4	B252-....	2000	1370	3370	2445	4:1	2.5:1	90°	710

F1 - F2 : BASKI KUVVETİ (EXERTING FORCE) , F3 - F4 : TUTMA KAPASİTESİ (HOLDING CAPACITY) , Fi : UYGULAMA KUVVETİ (APPLIED FORCE)



252-L



Kilitli / Locked

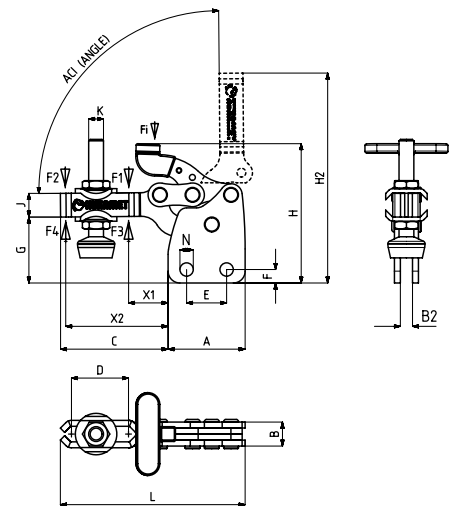

Ayak Tipi: Dikey Tabanlı
Body Mounting Base: Vertical



252-L

Sayfa/Page: 38



212

Sayfa/Page: 19



112

Sayfa/Page: 8

MODEL NO	A	B	B2	C	D	E	F	G	H	H2	J	K	L	N	X1	X2
252-2	26	8	4	36	17	13,5	4,5	22	47	71	8	M5	62	Ø 4.5	19	27
252-3	44	12	6	56	27	23	8	39,5	79	116,5	13	M8	100	Ø 7.5	27	43
252-4	64	16	8	79	37	35	11	56,5	114,5	164	19	M10	143	Ø 9	39	63